

# Specification sheet

REV.2

# Lithe 55Gen4 Fixed Down, Colour Round, 1.9" Architectural Downlight

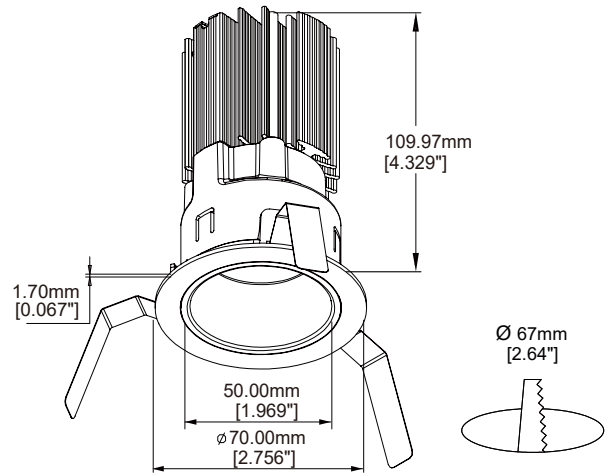

## Discription

LTE55G4FD is MACRON's latest innovation to challenge the physical limitation and strike a balance of aesthetics and performance. LTE55G4FD is capable of delivering upto 1100 lm and 15-degree tight beam with a remarkable 1.9" (50 mm) aperture and 40-degree light cutoff. Mini-flange design provides best visual-integration to the interior design, and option for flangeless application is also available. There are loads of options to choose from, including 4 beam angles, honey-comb louvre, trim styles and colors, and wet-location setup. LTE55G4FD is a exceptional recessed downlight loaded with most professional and unparalleled features.

## Features

<b>LED</b>	Lumiled Luxeon CX Plus
<b>Color temperature</b>	2700K/ 3000K/ 3500K/ 4000K
<b>Optics</b>	Spot 16° / Medium 26° / Wide 30° / Flood 40°
<b>Trim Finishes</b>	Black / White / Dark Blue / Glod / Matt Grey
<b>Trim Style</b>	Deep Bevel / Wet Location
<b>Ceiling Cutont</b>	Ø 67mm

## Performance

<b>Delivered output</b>	1002 lm (90+ CRI)
<b>Power consumption</b>	16 W max
<b>Color rendering</b>	90+CRI
<b>Color consistency</b>	3 SDCM
<b>CBCP</b>	Spot 7355cd/ Medium 5204cd/ Wide 3187cd/ Flood 946cd
<b>Lumen maintenance</b>	L80 B10 50,000 hrs

## Electrical and Control

<b>Input voltage</b>	36 vdc
<b>Input Current</b>	450mA Max
<b>Feature</b>	Thermal protector

## Construction

<b>Material</b>	Machining grade Aluminum
<b>Trim shape</b>	Round
<b>Lens</b>	Interchangeable TIR optics

## Rating/ Certification/ Warranty

- Dry and damp Locations
- RoHS compliant
- 5 years/ 50,000 hrs warranty

## Ordering Code Information

	PRODUCT	FLANGE STYLE	FLANGE COLOR	COLOR TEMP.	BEAM ANGLE	COLOR RENDERING
<b>LIGHTING FIXTURE</b>	<b>LTE55G4FD</b>	<b>RF</b>	<b>WH</b>	<b>27</b>	<b>S</b>	<b>9</b>
	LTE55Gen4 Fixed Down	RF Round Flange RL Round Flangeless SF Square Flange SL Square Flangeless	WH White BK Black	27 2700K 30 3000K 35 3500K 40 4000K	S Spot /16 deg. M Medium / 26 deg. W Wide / 30 deg. F Flood /40 deg.	9 90+CRI

	PRODUCT	TRIM STYLE	TRIM SHAPE	TRIM COLOR
<b>TRIM</b>	<b>LTE55 TR</b>	<b>BW</b>	<b>RD</b>	<b>WHGD</b>
	LTE 55 Trim	BVD Deep Bevel BW Bevel Wet location	RD Round SQ Square	WH White WHBK White \ Black WHGD White \ Gold WHBL White \ Dark Blue WHCE White \ Matt Grey BK Black BKGD Black \ Gold BKBL Black \ Blue BKCE Black \ Matt Grey

### Photometrics

MULTIPLYING FACTORS: (Multiplying Factor is based on 3000K-90+CRI IES file on website)

CCT	2700K-80+	3000K-80+	3500K-80+	4000K-80+
Factors	1.12	1.18	1.20	1.25

CCT	2700K-90+	3000K-90+	3500K-90+	4000K-90+
Factors	0.93	1.0	1.04	1.08

### Photometrics

Round | 16W | 90CRI | 3000K | Deep Bevel Trim

#### Spot 16°

Delivered Output : 1029lm | CBCP : 7355cd | Beam Angle : 16°

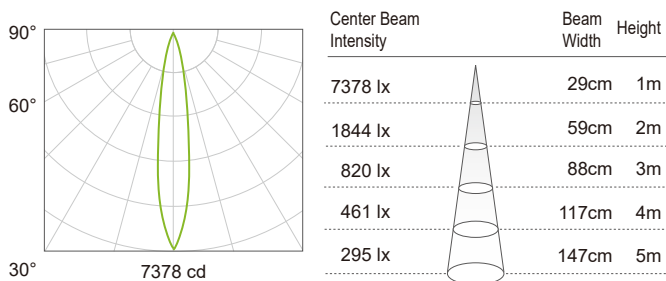

#### Medium 26°

Delivered Output : 1047 lm | CBCP : 5204 cd | Beam Angle : 26°

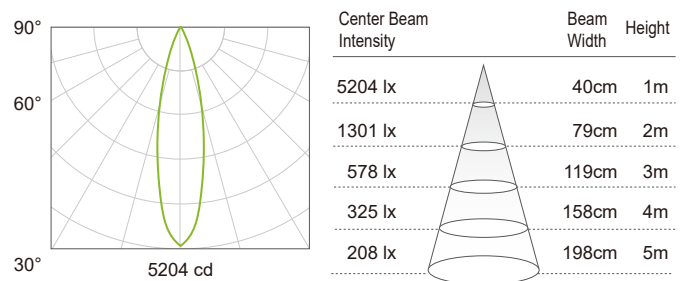

#### Wide 30°

Delivered Output : 1025 lm | CBCP : 3187 cd | Beam Angle : 30°

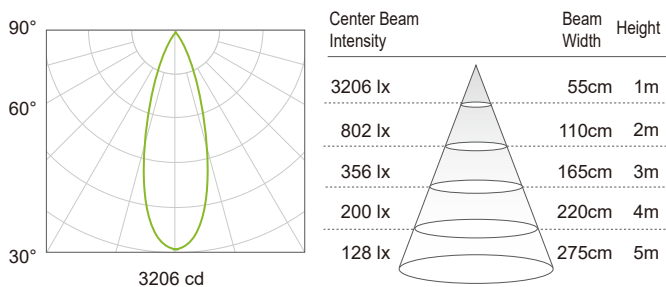

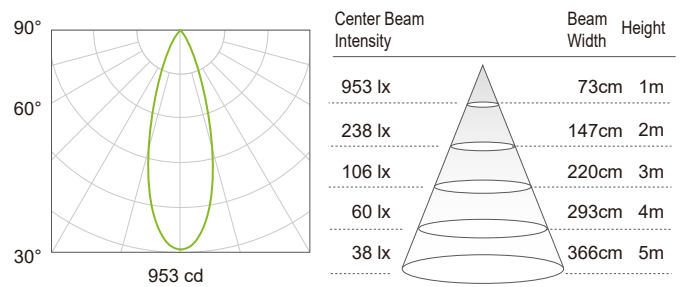

#### Flood 40°

Delivered Output : 947lm | CBCP : 630 cd | Beam Angle : 40°



### Optional Accessory

<b>PRODUCT</b>	<b>ACC.</b>	
LTE 55	SL	
LTE 55	SL Solite Lens	

<b>PRODUCT</b>	<b>ACC.</b>	
LTE 55	HCL	
LTE 55	HCL Honey Comb Louver	